

The Runtal® Family of Products

For Hydronic, Electric, and Steam Heating Systems

Runtal Commercial and Institutional Radiators

RUNTAL RADIATORS: Where Innovative

Runtal Radiators provide the unparalleled comfort of soft radiant heat, sleek Eurostyle design and a range of models and sizes to accommodate even the most demanding environments and applications. Comfort, style, energy efficiency, versatility and durability are all engineered into every radiator that Runtal builds. The panel radiator was invented in 1953 by Swiss engineer, Egon Runtal and architect, Jürg Altherr; thus the name Runtal. Since then Runtal has had millions of installations worldwide in schools, government buildings, hospitals, corporate offices, libraries, museums and homes. Over 30 years ago, a major commitment was made to the US and Canadian markets with the opening of a state-of-the-art factory in Ward Hill, MA (Haverhill).

Runtal is the world leader in Radiator Technology and Specialty Design. Runtal's flat steel tube construction provides maximum radiant comfort in a space saving design and is the choice of leading architects, engineers, and designers. Runtal Radiators may be discreetly blended into a classic décor or used as a bold complement to today's modern design.

Though originally intended exclusively for use in hydronic (closed loop hot water) heating systems, the Runtal line of radiators has expanded to include products that offer solutions for electric and steam heating systems as well. This brochure presents our complete line: from flat panel hydronic radiators to the Bisque Collection of high design radiators, to round tube towel radiators, to electric products (including the revolutionary Runtal Electric Baseboards and Wall Panels) and finally our unique designer steam products.

If you are in the Boston area, we cordially invite you to experience the beauty and practicality of Runtal at our gallery showroom in Ward Hill (Haverhill). We also encourage you to visit our extensive website: www.runtalnorthamerica.com for additional technical and specification information or call us at 800-526-2621 for your nearest Runtal Representative.

Cover photo: Prudential Center, Newark, NJ
The atrium is heated with Runtal curved perimeter style radiators.

Hydronic Radiators



pp. 4-12

Electric Radiators



pp. 14-16

Steam Radiators



pp. 16-17

Technology is Wedded to Unique Design

Runtal Radiators: The Best Choice

Style and Design Flexibility

Finally, a heating system which can blend into a traditional décor, highlight an ultra modern design or accent any style in-between. From baseboard to wall panels, to fancy curves and dramatic room dividers, Runtal manufactures the perfect welded steel radiator for every application. Since Runtal manufactures an almost unlimited selection of sizes, colors, and heat outputs it affords the architect and engineer choices. Innovation in architectural details is no longer limited by traditional heating systems. Runtal offers ten standard colors and over 100 optional colors, metallic finishes as well as color matching. Imagine the possibilities, confident that the final design will be comfortable and stylish.

Rugged Durability

Runtal's rugged all-welded steel construction ensures long life at peak operating efficiency. Runtal's powder coat finish provides a long-lasting, easy to maintain, protective finish.

Quiet, Comfortable Radiant Heating

Runtal Radiators provide an exceptionally quiet blanket of radiant warmth, without the drafts, cold spots, and dryness of most other heating systems.

Reduced Heating Costs

Runtal's broad radiating surface areas reduce energy consumption by providing soft, radiant comfort at lower thermostat settings.

Healthy

Hospitals have come to rely on Runtal for its designs are easy to clean, present minimal air movements, won't trap dust or dry out the air. Runtal offers as standard an antimicrobial paint in white and in other colors as optional.

Quick Turnaround and Efficient Installation

Stock products for immediate delivery and custom "made to order radiators" manufactured right in Ward Hill, Massachusetts means Runtal delivers exactly what you need, when you need it. Continuous mounting systems and individualized wrapping and tagging make Runtal Radiators easy to order, easy to locate on the job site and easy to install.

5-Year Limited Warranty

Runtal Radiators are warranted for five years against defects in materials or manufacturing.

Contents

Hydronic Products

Flat Panel Radiators	4
In Stock Product	8
Runtal NEO	9
Bisque Collection	10
Round Tube Towel Radiators	12
Accessories	13

Electric Products

Electric Baseboard	14
Baseboard Accessories	14
Electric Wall Panels	15
Electric Towel Radiators	16

Steam Products

Steam Radiators	17-18
---------------------------	-------

Technical Data

Hydronic , Electric & Steam	19
---------------------------------------	----

Flat Panel Radiators

The flat panel design is the essence of the Runtal line. The modular concept allows one to best achieve the required heat load in the most effective and aesthetic manner. Products are offered from 160 BTUH per foot to over 4000 BTUH per foot AWT of 180° at lengths from 20" to 29'6" in increments of 2". This flexibility allows the engineer and architect a heating solution for almost every project.



Perimeter Style

R
RF

- Provides an even blanket of radiant warmth around the perimeter with a sleek 2" depth
- Pipe cover trims are available for wall-to-wall continuous appearance.



Convective Style

R2F
R3F

- Ideal for glass wall or limited sill height applications
- Can be designed for wall, pedestal, mullion, or cantilever mounting



Vertical Style

RV

- Heat areas with limited perimeter space, such as entryways and stairwells
- Provide heat in otherwise unused space, such as behind columns or doors

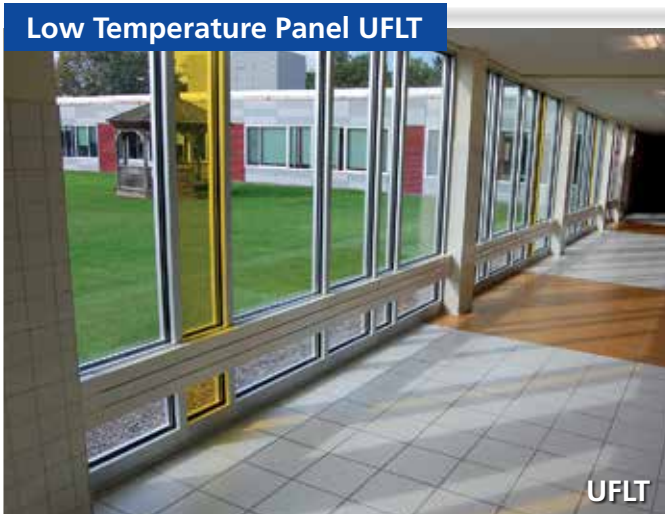

Low Temperature Panel UFLT

UFLT

- A low temperature double-sided radiator for glass wall installation
- The inactive front panel provides a low temperature surface to the room.



Thermotouch

TT

- Designed for low surface temperature applications such as schools and hospitals
- Surface temperatures up to 60°F less than the supply water temperature

Curved and Other Specialty Styles



- May be field curved to a 15' (or greater) radius, or factory curved to a radius from 5' to 20'
- Angled radiators are available for bay windows

Wall Panel



- Ideal centered under a window
- Perfect replacement for old cast iron radiators

Ceiling Style



- Provides heat in spaces with no available wall space; like entryways or stairwells
- Excellent overhead radiant heating for maintenance or sports facilities

Column Radiators



- Ideal for floor-to-ceiling glass applications, allowing light to shine between the tubes
- Can be designed for wall, pedestal, or mullion mounting

Omnipanel Style



- Ideal for hotel, corporate and dormitory bathrooms
- Source of heat for the bathroom as well as towel dryer and warmer

The following is a key to the models offered:

Model R:
R radiators are primarily radiant, mount horizontally and consist of steel panels through which the water passes.

Model RF:
RF radiators are more convective, mount horizontally and consist of a row of steel panels with hidden fins on the backside.

Model R2F:
R2F radiators are mounted horizontally and consist of two rows of fins sandwiched between two layers of panels.

Model R3F:
R3F radiators are mounted horizontally and consist of two layers of fins sandwiched between two layers of panels and a third row of fins on the backside.

Model RV:
RV radiators are mounted vertically and consist of steel panels only.

Model RC:
RC radiators are made for ceiling applications and consist of steel panels only.

Model RS2:
RS2 radiators have the tubes positioned vertically and sideways.

Model TW:
The Omnipanel is a wall panel with missing panels to hang towels or clothing to warm or dry.

Model TT:
TT is a radiator which has a hidden second panel in which the water passes and provides a low surface temperature up to 60° F less than the water temperature passing through the radiator.

Model UFLT:
The UFLT has an inactive panel added to the front of the RF radiator resulting in a low surface temperature.

Heating Capacities

Runtal Radiators have been tested to ISO standards #3147-3150 for panel radiation. The ratings shown in the tables are based on a 65°F (18°C) entering air temperature, and include a 15% heat effect factor.

To determine the rating of a radiator at an average water temperature (AWT) other than what is shown in the tables, multiply the rating at 215°F (102°C) by the appropriate factor in the table below.

CORRECTION FACTOR AT AVERAGE HEATING WATER TEMPERATURE

Temperature	215°F	200°F	190°F	180°F	170°F	160°F	150°F	140°F	130°F	120°F	110°F
Correction Factor	1.0	.87	.79	.70	.63	.55	.51	.40	.33	.27	.21

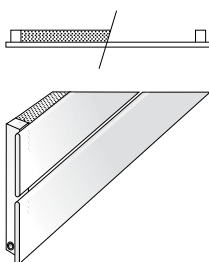
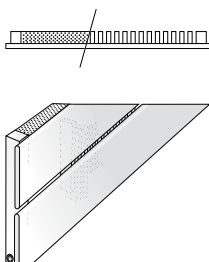
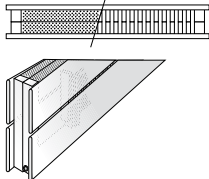
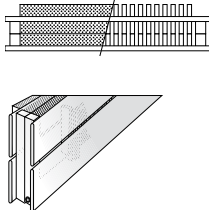
	MODEL	UNIT HEIGHT INCHES	MOUNTING DEPTH INCHES	215°F BTUH/FT	180°F BTUH/FT	140°F BTUH/FT
R MODELS 	R-1	2.8	2.0	230	160	90
	R-2	5.7	2.0	420	300	170
	R-3	8.6	2.0	620	440	250
	R-4	11.5	2.0	820	580	330
	R-5	14.4	2.0	1020	720	410
	R-6	17.3	2.0	1220	860	500
	R-7	20.2	2.0	1430	1010	580
	R-8	23.1	2.0	1640	1160	660
	R-9	26.0	2.0	1850	1300	750
	R-10	29.0	2.0	2060	1450	830
RF MODELS 	RF-1	2.8	2.0	550	390	220
	RF-2	5.7	2.0	870	620	350
	RF-3	8.6	2.0	1120	790	460
	RF-4	11.5	2.0	1360	960	550
	RF-5	14.4	2.0	1720	1210	700
	RF-6	17.3	2.0	1990	1400	800
	RF-7	20.2	2.0	2150	1510	880
	RF-8	23.1	2.0	2390	1680	970
	RF-9	26.0	2.0	2530	1780	1020
	RF-10	29.0	2.0	2660	1880	1080
R2F MODELS 	R2F-1	2.8	5.0	980	690	400
	R2F-2	5.7	5.0	1590	1120	640
	R2F-3	8.6	5.0	2020	1420	820
	R2F-4	11.5	5.0	2420	1700	980
	R2F-5	14.4	5.0	3100	2180	1250
	R2F-6	17.3	5.0	3470	2450	1400
R3F MODELS 	R3F-1	2.8	5.0	1300	920	530
	R3F-2	5.7	5.0	2020	1420	820
	R3F-3	8.6	5.0	2580	1810	1040
	R3F-4	11.5	5.0	3090	2170	1250
	R3F-5	14.4	5.0	3790	2670	1530
	R3F-6	17.3	5.0	4270	3000	1720

LENGTHS AVAILABLE IN 2" INCREMENTS FROM 20" TO 29'6".

RV MODELS

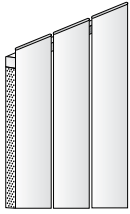

MODEL	UNIT HEIGHT INCHES	MOUNTING DEPTH INCHES	215°F BTUH/FT	180°F BTUH/FT	140°F BTUH/FT
RV-2	5.7	2.0	400	290	160
RV-3	8.6	2.0	600	430	250
RV-4	11.5	2.0	800	570	330
RV-5	14.4	2.0	1000	710	410
RV-6	17.3	2.0	1200	850	490
RV-7	20.2	2.0	1400	990	570
RV-8	23.1	2.0	1600	1130	650

RC MODELS

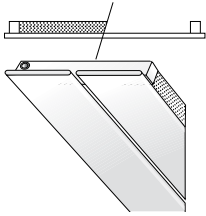

RC-2	5.7	3.0	270	190	110
RC-3	8.6	3.0	400	290	170
RC-4	11.5	3.0	530	380	220
RC-5	14.4	3.0	660	470	270
RC-6	17.3	3.0	800	560	320
RC-7	20.2	3.0	940	660	380
RC-8	23.1	3.0	1070	760	430

RS2 MODELS

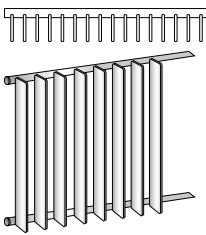

RS2-16	16.0	4.0	1380	960	540
RS2-24	23.6	4.0	1920	1320	780
RS2-30	29.5	4.0	2280	1620	900
RS2-36	35.6	4.0	2640	1860	1080
RS2-78	78.8	4.0	6300	4380	2520
RS2-84	84.6	4.0	6780	4740	2700

UFLT MODELS



UFLT-2	5.7	2.0	867	610	347
UFLT-3	8.6	2.0	1118	787	448
UFLT-4	11.5	2.0	1351	951	541
UFLT-5	14.4	2.0	1718	1209	688

THERMOTOUCH MODELS

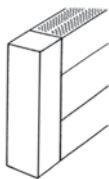

TT-2F	6.0	3.3	870	610	349
TT-3F	9.0	3.3	1120	784	451
TT-4F	12.0	3.3	1360	952	544

OMNIPANEL MODELS

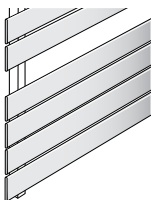

HYDRONIC OMNIPANELS (180°F RATING SHOWN)

MODEL	UNIT HEIGHT INCHES	16" WIDE BTUH	20" BTUH	24" BTUH	30" BTUH	36" BTUH
TW9	26.1	1600	2000	2400	3000	3600
TW12	34.8	1920	2400	2880	3600	4320
TW15	43.6	2400	3000	3600	4500	5400
TW18	52.3	3040	3800	4560	5700	6840
TW21	61.1	3520	4400	5280	6600	7920

DEPTH: 3.8"

In Stock Radiators for Immediate Delivery

For projects on a short-time frame Runtal offers stock radiators in many sizes and styles.

Baseboard style is offered in three heights and fifteen lengths. Wall panels are offered in two heights and three lengths. Vertical panels are offered in two heights and two widths. These products are available for immediate delivery in white and the other standard colors are available within two weeks.

The stock baseboard and wall panel styles have multiple tapings that allow the option of any bottom or side opposite end piping connections. All stock vertical panels have bottom tapings and an air vent tapping on either side allowing the option of having the supply on either the right or left side.

In Stock Baseboard UF Series



Runtal offers 2, 3 and 4 panels high baseboards in white for immediate delivery in 2', 2.5', 3', 3.5', and from 4'-14' in even foot increments. All stock baseboards have multiple tapings (AB) that allow for all types of opposite end bottom and side piping connections. Stock baseboards may be special ordered in any of the other nine standard colors with a two-week delivery.

MODEL	UNIT HEIGHT INCHES	MOUNTING DEPTH INCHES	215°F BTUH/FT	180°F BTUH/FT	140°F BTUH/FT
UF-2	5.7	2.0	870	620	350
UF-3	8.6	2.0	1120	790	460
UF-4	11.5	2.0	1360	960	550

In Stock Wall Panels UF Series

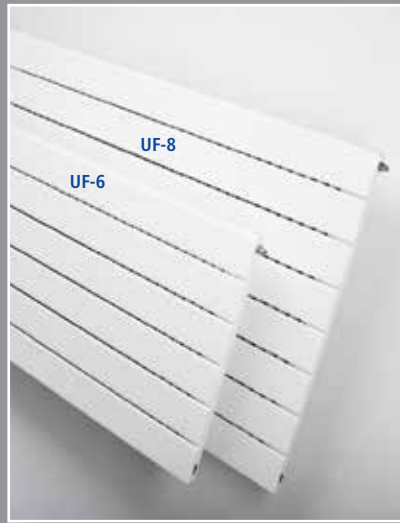

Runtal offers 2 wall panels (6 and 8 panels) in 2', 3', and 4' lengths in white for immediate delivery. All stock wall panels have multiple tapings (AB) that allow for all opposite end bottom and side piping connections. Stock wall panels may be special ordered in any of the other nine standard colors with a two-week delivery.

MODEL	UNIT HEIGHT INCHES	MOUNTING DEPTH INCHES	215°F BTUH/FT	180°F BTUH/FT	140°F BTUH/FT
UF-6	17.3	2.0	1990	1400	800
UF-8	23.1	2.0	2390	1680	970

In Stock Vertical Panels UHX Series

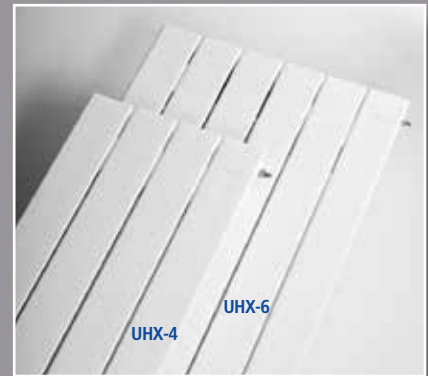

Runtal offers vertical panels (4 and 6 panels wide) in 3' and 6' heights for immediate delivery in white. All stock vertical panels have bottom tapings and air vent tapings on both sides allowing flexibility of supply and return. Stock vertical panels may be special ordered in any of the other nine standard colors with a two-week delivery.

MODEL	UNIT WIDTH INCHES	MOUNTING DEPTH INCHES	215°F BTUH/FT	180°F BTUH/FT	140°F BTUH/FT
UHX-4	11.5	2.0	800	570	330
UHX-6	17.3	2.0	1200	850	490

Runtal NEO

Runtal North America, Inc. Introduces the Runtal NEO: The Radiator for Today, Tomorrow and Beyond

The revolutionary Runtal NEO (New Energies Optimized) combines the sleek and elegant lines of a Runtal panel with a heat exchanger and low voltage fans to provide a large heating capacity in a small compact unit. The Runtal NEO provides high outputs when using low temperature heating solutions such as: heat pumps, solar-thermal systems or condensing boilers. In mild conditions, the radiator can operate without fans to create radiant comfort. As conditions grow colder, three stages of fans boost the radiator's output to keep the space warm and comfortable with nearly silent fan operation. The Runtal NEO is available in two heights (17.5" and 23.3") and four lengths (31.5", 39.4", 47.2" and 59"). The Runtal NEO offers outputs up to 13,850 BTUH per unit.

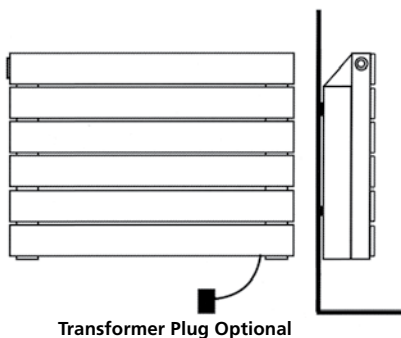

MODEL	HEIGHT INCHES	DEPTH INCHES	LENGTH INCHES	160°F BTUH	140°F BTUH	120°F BTUH
NEO 6-800	17.5	4.6	31.5	5101	4057	3020
NEO 6-1000	17.5	4.6	39.4	7882	6330	4774
NEO 6-1200	17.5	4.6	47.2	9458	7599	5729
NEO 6-1500	17.5	4.6	59.0	12874	10441	7971
NEO 8-800	23.3	4.6	31.5	5487	4344	3207
NEO 8-1000	23.3	4.6	39.4	8479	6776	5074
NEO 8-1200	23.3	4.6	47.2	10175	8031	6087
NEO 8-1500	23.3	4.6	59.0	13850	11175	8469

Bisque Collection

Runtal is pleased to offer the Bisque Collection, a series of radiators from European designers and artisans. These radiators offer a sense of sculpture to a design where an architectural statement is desired.

Flow Form

The sleek and functional design of the Flow Form presents the nostalgic charm of early industrial design as well as providing a dramatic twist to modern design. They are ideal for use in lofts, studios and galleries, or rooms where a deliberate design statement is made.



Hot Spring

Brilliantly imaginative, the mesmerizing and stylish design of the Hot Springs makes a real statement in a corporate setting.

MODEL	HEIGHT INCHES	DEPTH/DIA. INCHES	LENGTH INCHES	215°F [*] BTUH	180°F [*] BTUH	140°F [*] BTUH
Flow Form* (in stock) in a selection of finishes						
XFF-100	7.5	5.2	39.4	3625	2553	1455
XFF-150	7.5	5.2	59.1	5566	3920	2234
XFF-200	7.5	5.2	78.8	7059	5288	3014
Hot Spring (in stock) in a selection of finishes						
HOT 60	25.6	11.0		2805	1975	1126
HOT 180	72.8	11.0		9487	6681	3808

^{*}Custom lengths available in all Runtal colors in lengths from 16" to 156" in increments of 2" and in chrome up to 80".

Round Tube Towel Radiators

Runtal offers a variety of towel radiator designs for hydronic applications and operate in conjunction with the central heating system.

The Runtal round tube towel radiators offer the same benefits of the flagship Omnipanel: being both a room heater and towel warmer and ideal for hotel, corporate and dormitory bathrooms. A variety of sizes are offered with outputs ranging from 1000 to 4150 BTUH per unit.

All Runtal Towel Radiators are designed to maximize towel warming capacity by offering a large heated surface area. There are few sensations in the world which match the feel of a toasty towel or bathrobe after bathing. Runtal Towel Radiators will also help reduce mold and mildew and keep towels fresh between laundering.



Runtal Neptune®



Runtal Radia®



Runtal Fain®



Runtal Solea®

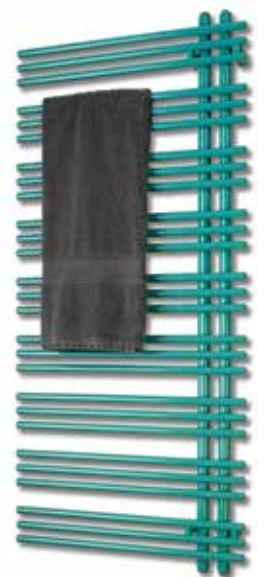

Runtal Versus®

Hydronic Radiator Accessories

Runtal offers an array of accessories to finish the Runtal look.

Pedestal and Cantilever Mounting Options

KR10 Floor Post



KR20 Pedestal



KR30
Cantilever Bracket



KR-4 Pedestal



Valve Options

Runtal offers a variety of shut-off and thermostatic valves in both straight and angle configurations. The decorative valves are made to be exposed and the other valves can either be exposed or will fit behind Runtal trim covers. All valves are 1/2" NPT and those with an * are also available in 3/4" NPT.

Shut-off valves offer the aesthetics of radiator valves, and provide easy isolation of radiators.



Thermostatic control valves offer a range of temperature settings. They will maintain the temperature at a level you have selected by automatically adjusting the heat output from the radiator.



Trim Covers

Runtal offers a complete line of trim covers for both single (shown) and double panels models as well as for the Thermotouch and UFLT products. These covers are made to cover piping and contribute to a finished look.

Center Trim

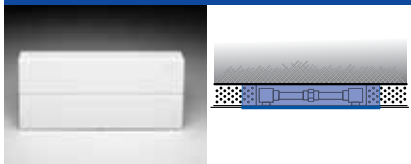

Inside Corner Trim

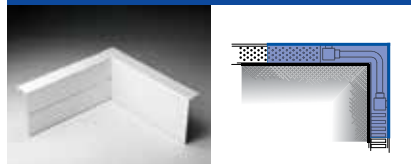

End Cap Trim



End Trim

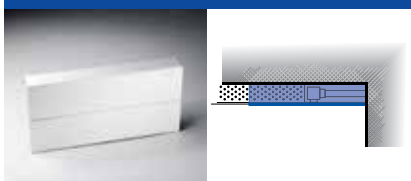

Outside Corner Trim



Vertical Pipe Trim

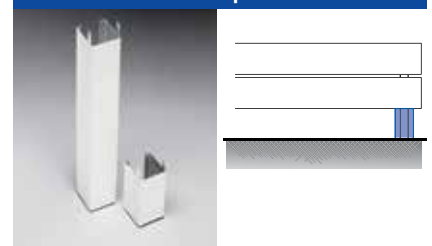

Electric Baseboard

Runtal's revolutionary dry electric baseboard design is a radiator for any application.

Runtal's electric baseboard combines high output and low surface temperature in a durable flat tube design. Runtal's electric baseboard is available in 120, 208, and 240 volt configurations from 3' to 10' lengths in increments of one foot.

Runtal Electric Baseboard offers either end wiring and bottom, rear and side knockouts for easy installations.



Runtal offers an optional pedestal base and trim covers. The Runtal Electric Baseboard Pedestal accessory enables the wall-mounted electric baseboard to be converted into a free standing unit which is finished on both sides.

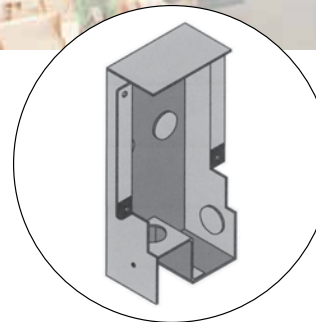

Runtal's junction box offers knockouts for back, side and bottom wiring.

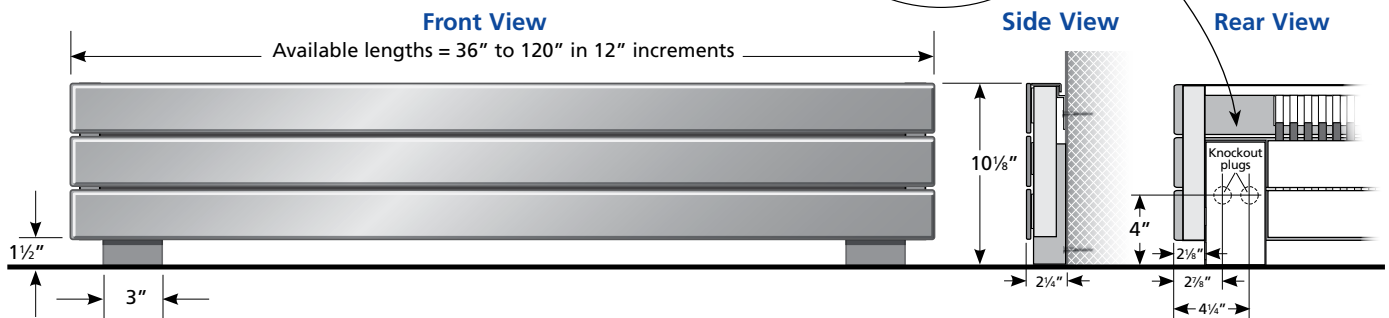

Baseboard Heating Capacities (BTUH)

MODEL NUMBER: EB-3

AVAILABLE LENGTHS

	36"	48"	60"	72"	84"	96"	108"	120"
BTUH output	1500	2000	2500	3000	3500	4000	4500	5000
Watt output	440	586	733	879	1026	1172	1319	1466
Amp draw 120 Volts	3.7	4.9	6.1	7.3	8.6	9.8	11.00	12.2
Amp draw 208 Volts	2.1	2.8	3.5	4.2	4.9	5.6	6.3	7.0
Amp draw 240 Volts	1.8	2.4	3.1	3.7	4.3	4.9	5.5	6.1

Electric Wall Panels

Runtal Wall Panels are ideal for placement under windows or on walls where floor space is at a premium.

When placed under windows, wall panels help eliminate cold spots and drafts while allowing curtains to hang properly to the floor. The Runtal Electric Wall Panels are available in two heights (17¼" & 23⅞") and three lengths (2', 3', & 4'). They are available in 120, 208 and 240 volt configurations wiring is from the rear.



Runtal offers two wall panel sizes and three lengths.

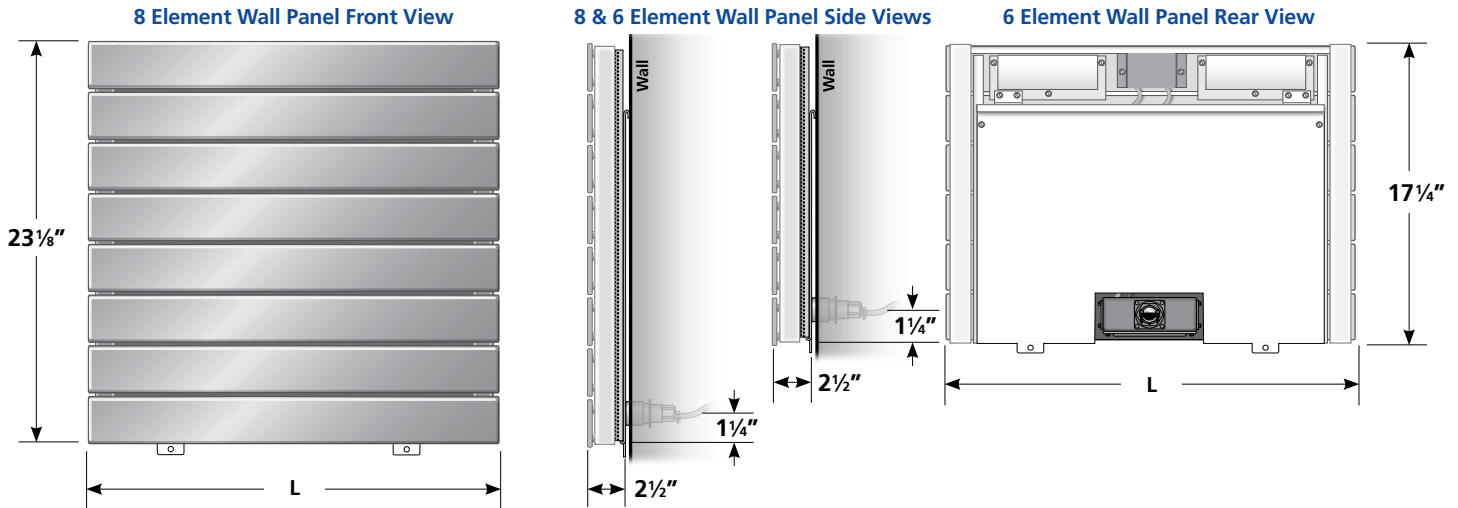

Electric Wall Panel Heating Capacities (BTUH)

MODEL NUMBER	AVAILABLE LENGTHS			WEIGHT
	24"	36"	48"	
EWP-6				
BTUH output	2013	3003	4026	15 lbs./ft.
Watt output	590	880	1180	
Amp draw 120 Volts	4.9	7.3	9.8	
Amp draw 208 Volts	2.8	4.2	5.7	
Amp draw 240 Volts	2.5	3.7	4.9	
EWP-8				
BTUH output	2627	3924	5220	20 lbs./ft.
Watt output	770	1150	1530	
Amp draw 120 Volts	6.4	9.6	12.8	
Amp draw 208 Volts	3.7	5.5	7.4	
Amp draw 240 Volts	3.2	4.8	6.4	

Electric Towel Radiators

Runtal electric towel radiators may be used as sole or supplemental heat source for a bathroom. They offer the advantage of four season use.

Runtal electric towel radiators operate on 120 volts, (Omnipanel II operates at 120, 208, 240 volts) and are available in models that offer 800 to 3072 BTUH. They are independent of the central heating system and may be the sole or supplemental heat for a room.

Available in either direct wire or plug-in versions, Runtal electric towel radiators offer low, medium and high settings. They may be used with our optional programmable controller.

There are few sensations in the world that match the feel of a toasty towel or bathrobe after bathing. Runtal towel radiators also help reduce mold and mildew and keep towels fresh between laundering.



Runtal Radia®



Runtal Solea®



Runtal Omnipanel II®



Runtal Versus®



Runtal Neptune®



Runtal Fain®

Steam Radiators

Runtal affords the ability to better utilize room space, by offering sleek replacement radiators in both classical and contemporary styles.

Steam Flow Form

The sleek floor-mounted Steam Flow Form presents the nostalgic charm of early design. The industrial heating elements of the Steam Flow Form appear as beautiful objects of their own right. The spiral fins add a dramatic twist to modern design. The Steam Flow Form operates specifically with a two pipe steam system.

Steam Flow Form

MODEL	HEIGHT INCHES	DIAMETER INCHES	LENGTH INCHES	215°F BTUH OUTPUTS
SFF-36	7.5	5.2	36.0	3312
SFF-72	7.5	5.2	72.0	6881

Steam Radiators, *continued*

Steamview

The wall-mounted Steamview offers a sleek contemporary replacement of bulky cast iron radiators and will operate with both one and two pipe steam systems.



Steamview

Charleston Pro

The wall-mounted Charleston Pro offers a sleek classical design replacement of bulky cast iron radiators and will operate with both one and two pipe steam systems.



Charleston Pro

Steamview

MODEL	HEIGHT INCHES	DEPTH INCHES	LENGTH INCHES	215°F BTUH
SV16-24	15.8	2.5	23.3	2564
SV16-36	15.8	2.5	34.7	3763
SV16-48	15.8	2.5	47.4	5104
SV16-60	15.8	2.5	58.8	6306
SV16-72	15.8	2.5	71.5	7646
SV-24-24	23.6	2.5	23.3	3553
SV-24-36	23.6	2.5	34.7	5225
SV-24-48	23.6	2.5	47.4	7106
SV-24-60	23.6	2.5	58.8	8778
SV-24-72	23.6	2.5	71.5	10659

Charleston Pro

MODEL	HEIGHT INCHES	DEPTH INCHES	LENGTH INCHES	215°F BTUH
CP16-24	15.8	4.0	25.1	2990
CP16-36	15.8	4.0	36.0	4370
CP16-48	15.8	4.0	48.7	5980
CP16-60	15.8	4.0	61.3	7590
CP16-72	15.8	4.0	72.2	8970
CP24-24	23.6	4.0	25.1	4654
CP24-36	23.6	4.0	36.0	6820
CP24-48	23.6	4.0	48.7	9308
CP24-60	23.6	4.0	61.3	11814
CP24-72	23.6	4.0	72.2	13962

Technical Data for Installation of Radiators

Technical Data for Hydronic Radiators

Closed Loop System Required

Runtal Radiators are manufactured of cold rolled low carbon steel and should be used only in a closed loop hydronic system. Fully venting the panels and system of air is critical. This will allow adequate water flow throughout the panels for proper operation.

Radiator Pressure Ratings

- Standard Pressure Tube/Rating 56 psi Max-Tested at 74 psi
- Medium Pressure Tube/Rating 85 psi Max-Tested at 110 psi
- High Pressure Tube/Rating 128 psi Max-Tested at 184 psi.

Pressure Drop Considerations

Individually piped Runtal Radiators have minimal pressure drops, usually less than 0.5 feet of head per radiator. Medium and high pressure radiators have slightly higher pressure drops than the equivalent standard pressure model. To calculate specific pressure drop values for projects in design, contact your Runtal Sales Representative.

Flow Rate Considerations

Flow rates with Runtal may differ from flow rates with fin-tube products by virtue of the Runtal flat tube design. Turbulent flow for good heat transfer is achieved at comparably lower flow rates with flat tubes than with round tubes. The resulting lower flow rates can provide higher delta T's, lower average water temperatures, and allow the use of smaller pumps for better system efficiency.

Piping Arrangements

Runtal offers several different piping configurations with the most popular illustrated below. For other connection options, please consult your Runtal Representative.

Series Piping Arrangements

A same end series with Runtal produces equivalent average water temperatures in all the radiators, and in some cases can reduce the system piping required.

Left hand Supply shown — Right hand supply available

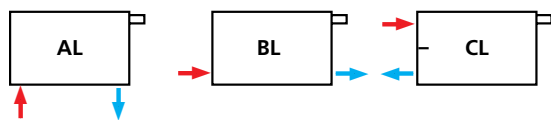

Same End Series — 3 Radiators maximum



Opposite End Series — 7 Radiators (100 feet) maximum

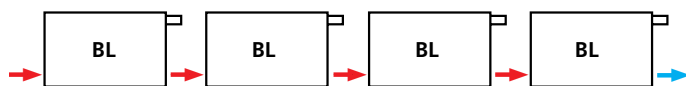

Opposite End Series can be piped with Runtal Radiators according to standard perimeter heating designs.

Radiator Expansion

Runtal Radiators will expand during normal operation to a maximum of 0.16 inch per foot at 215° F. Proper expansion compensation should be provided in the piping, especially in series piping.

Technical Data for Electric Radiators

Connect multiple radiators in parallel: Multiple radiators must be connected in parallel and not in a series.

Connect to a switching device: Runtal electric radiators must be connected to a switching device or a relay thermostat switch.

Maximum wattage on a circuit: For installation of multiple electric radiators, the following chart should be used. The chart indicates supply voltage, circuit breaker rating, minimum wire size, and maximum total wattage of electric units on the circuit.

VOLTAGE A.C.	CIRCUIT BREAKER SIZE	MAXIMUM WATTAGE	WIRE SIZE
120	15 Amp	1440	14/2 with Ground
120	20 Amp	1920	12/2 with Ground
120	30 Amp	2880	10/2 with Ground
208	15 Amp	2496	14/2 with Ground
208	20 Amp	3328	12/2 with Ground
208	30 Amp	4992	10/2 with Ground
240	15 Amp	2880	14/2 with Ground
240	20 Amp	3840	12/2 with Ground
240	30 Amp	5760	10/2 with Ground

Technical Data for Steam Radiators

Pitching the Radiator: Steam Radiators must be tilted at least 1/16" per foot towards the condensate return.

Runtal Colors

Standard Colors



Metallic Colors

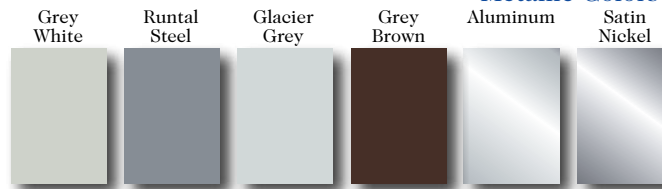

As well as colors shown above, Runtal offers a selection of 100 Optional Colors.

Printed colors are not an exact representation, so please contact Runtal for a "Color Selection Guide."

The World's
Finest
Panel Radiators

Over 25 Years'
Experience
in North America

World Leader
in Radiator
Technology

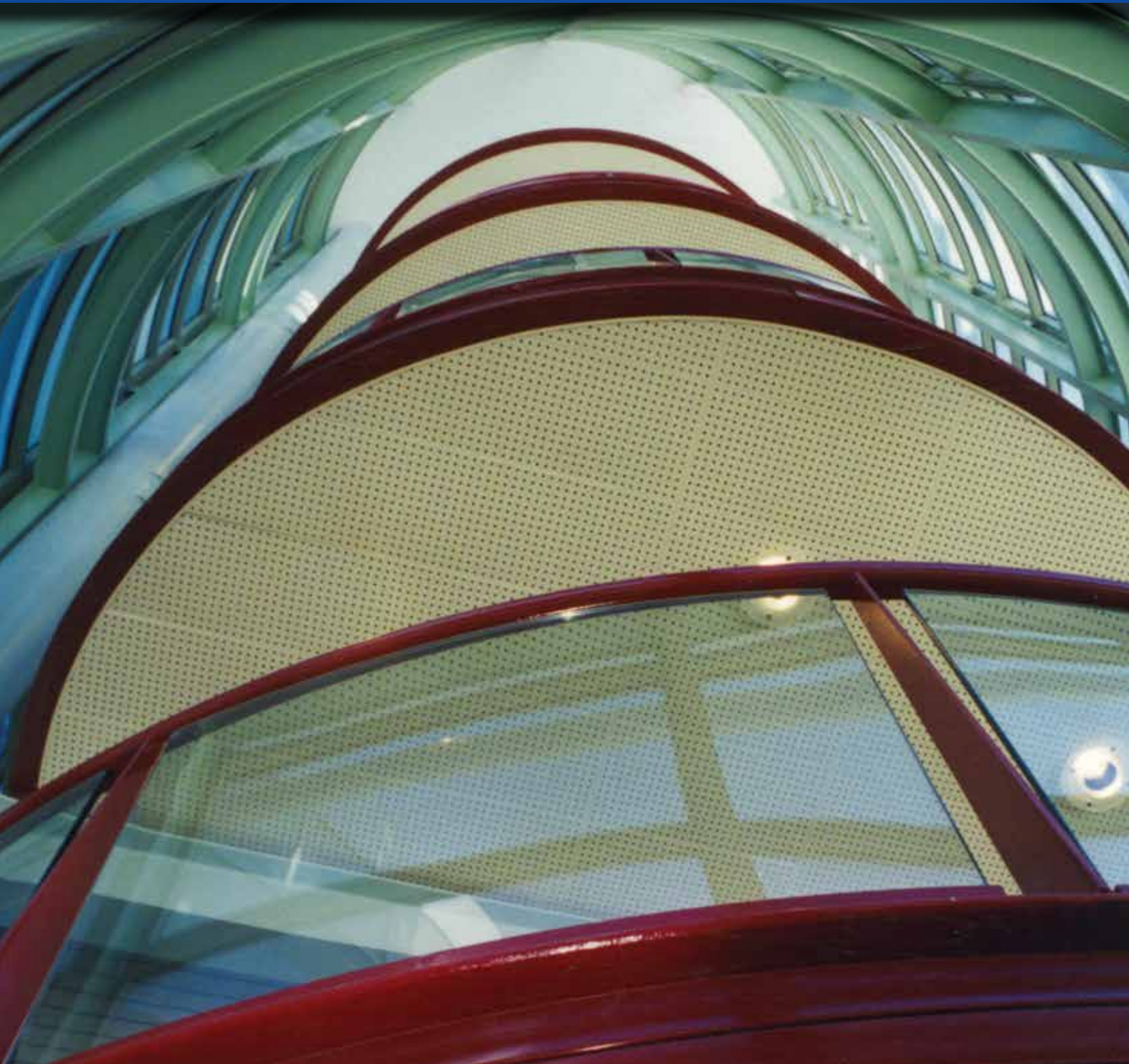

Runtal North America, Inc.
PO Box 8278,

187 Neck Road Ward Hill, MA 01835

TEL: 800-526-2621 FAX: 978-372-7140

In Canada: 888-829-4901

www.runtalnorthamerica.com



Photo: Lerner College of Medicine & Research Institute, Cleveland Clinic, Cleveland, Ohio
Curved Runtal Radiators are found on each level of the stairwell.